

深圳市色彩光电有限公司  
**Shenzhen LED Color Opto Electronic Co.,ltd**

4-5th floor Dadong Ming Science and Technology Park Yuequn road Changzhen Viliage Guangming New District Shenzhen

Tel:+86-0755-27350605

Fax:+86-0755-2324-5913

**LC8812 LED SERIES**  
**SPECIFICIFATION**  
**INTEGRATED LIGHT SOURCE INTELLIGENT CONTROL SMD LED**

**Document No.: SPC/ LC8812 LED**

**Model No.: LC8812**

**Description: 5.5x5.0x1.6mm Intelligent control SMD LED**



## **1. General description**

LC8812 is a external controlled intelligent LED with control circuit and light emitting circuit in one 5050 components. Each LED is a pixel, The pixel contains the intelligent digital interface data latch signal shaping amplifier driving circuit, power supply voltage regulator circuit, built-in constant current circuit, high precision RC oscillator, and the output driver adopts patented PWM technology, which Effectively ensure that the color of each pixel is consistent

The data protocol being used is unipolar NRZ communication mode. After the pixel power-on reset, the DIN port receive data from controller,When the frist 24-bit data is extracted by the first pixel and sent to Data latch which inside the pixel ,The remaining data is processed by the internal shaping circuit, The remaining data is shaped and amplified by the internal shaping processing circuit, and then the output is forwarded to the next cascaded pixel through the DO port. The Data transmission through each pixel, the signal will reduce 24bit , The pixel is reset after the end of DIN. Using automaticshaping forwarding technology makes the number of cascaded pixels without signal transmission, only limited by signal transmission speed.

The LED has alow driving voltage, environmental protection and energy saving,high brightness, scattering angle, good consistency, low power, and long lifespan . The control circuit is integrated in the LED ,which make Components smaller and more easier to install.

## **2. Applications**

- Full-color module, Flexible led Strip ,Rigid led strip
- LED decorative lighting, LED Panel a variety of electronic products, electrical equipment etc

## **3. Main Feature**

- SMD internal integrated high quality external control line serial cascade constant current IC;
- Control circuit and the RGB chip integrated in SMD 5050 components, to form a complete external control pixel, make the color mix uniformity and consistency;
- Built-in data shaping circuit, a pixel signal is received after wave shaping and output waveform distortion will not guarantee a line;
- Gray level adjusting circuit (256 level gray scale adjustable);
- Red drive special treatment, color balance;
- Single-line data transmission for unlimited cascade
- Plastic forward strengthening technology, the transmission distance between two points over 10M;
- Data transmission frequency can reach 800 Kbps, when the refresh rate of 30 frames per sec,the number of cascades is not less than 1024 points.

**4. Product Naming**

LC8812 mean white surface ,12-13ma/channel ,capacitor integrated in 5050 (standard version)

LC8812B mean white surface,12-13ma/channel, without capacitor intergrated in 5050

LC8812-B mean black surface ,12-13ma/channel ,capacitor integrated in 5050

LC8812B-B mean black surface,12-13ma/channel, without capacitor intergrated in 5050

**5. Mechanical Dimensions:**

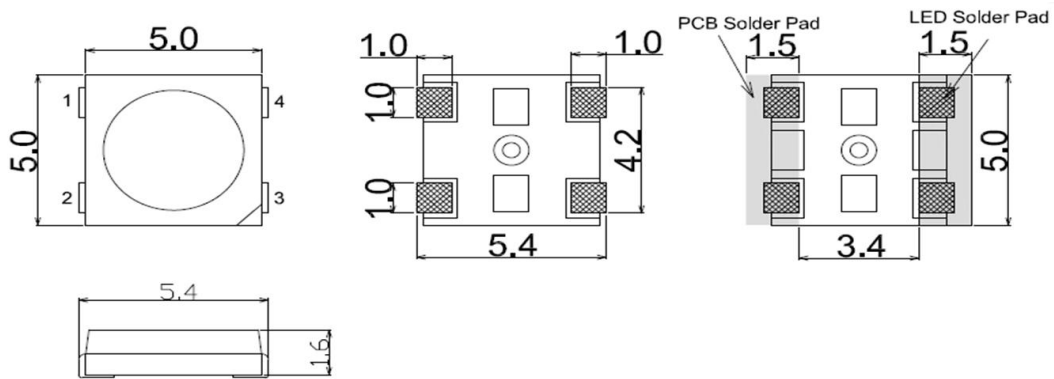

Notes:

1. All dimensions are in millimeters.
2. Tolerance is  $\pm 0.1$ mm unless otherwise noted

**6. Pin Configuration:**

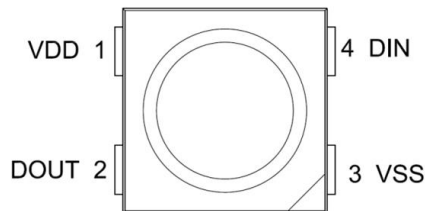

NO.	Symbol	Function description
1	VDD	Power supply LED
2	DOUT	Control data signal output
3	VSS	Ground
4	DIN	Control data signal input

**深圳市色彩光电有限公司**  
**Shenzhen LED Color Opto Electronic Co.,ltd**

---

**7. Absolute Maximum Ratings (Ta=25°C,VSS=0V) :**

Parameter	Symbol	Range	Unit
Power supply voltage	VDD	+3.5~+5.5	V
Logic input voltage	V <sub>IN</sub>	-0.5~VDD+0.5	V
Working temperature	Topt	-40~+85	°C
Storage temperature	Tstg	-50~+150	°C
ESD pressure	V <sub>ESD</sub>	4K	V

**8. RGB LED photoelectric parameters**

Color	LC8812 RGB LED Series 12ma		
	Wavelength	MCD	Lumen
Red	620-623nm	400-700mcd	1.0-2.0lm
Green	517.5-520nm	1000-1500mcd	3.0-4.0lm
Blue	467.5-470nm	200-400mcd	0.5-1lm

**9. The electrical parameters (unless otherwise specified, TA=-20 ~ +70 °C , VDD=4.5 ~ 5.5V,VSS=0V):**

Parameter	Symbol	Min	Typical	Max	Unit	Test conditions
The chip supply Voltage	VDD	---	5.2	---	V	---
R/G/B port pressure	VDS,MAX	---	---	26	V	---
DOUT drive capability	IDOH	---	49	---	mA	DOUT connect ground, the maximum drive current
	IDOL	---	-50	---	mA	DOUT connect +, the largest current
The Signal Input flip threshold	VIH	3.4	---	---	V	VDD=5.0V
	VIL	---	---	1.6	V	
The frequency of PWM	FPWM	---	1.2	---	KHZ	---
Static power consumption	IDD	---	1	---	mA	---

**10 The dynamic parameters (Ta=25 °C):**

Parameter	Symbol	Min	Typical	Max	Unit	Test conditions
The speed of data transmission	FDIN	---	800	---	KHZ	The duty ratio of 67% (data 1)
DOOUT transmission delay	TPLH	---	---	500	ns	DIN→DOOUT
	TPHL	---	---	500	ns	
OUT Rise/Drop Time	Tr	---	100	---	ns	VDS=1.5 IOUT=13mA
	Tf	---	100	---	ns	

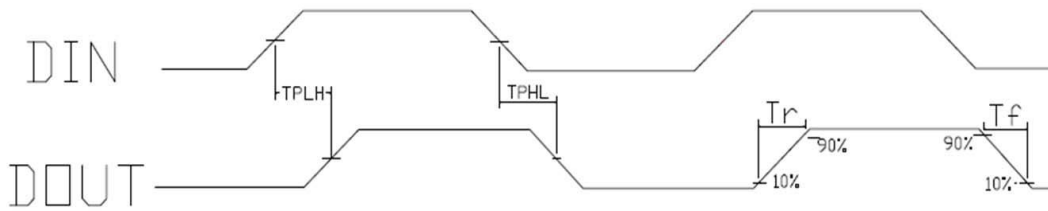

**11. The data transmission time (TH+TL=1.25μs ± 600ns)**

T0H	0 code, high level time	0.3μs	±0.15μs
T0L	0 code, low level time	0.9μs	±0.15μs
T1H	1 code, high level time	0.6μs	±0.15μs
T1L	1 code, low level time	0.6μs	±0.15μs
Trst	Reset code, low level time	80μs	±0.15μs

**12. Timing waveform:**

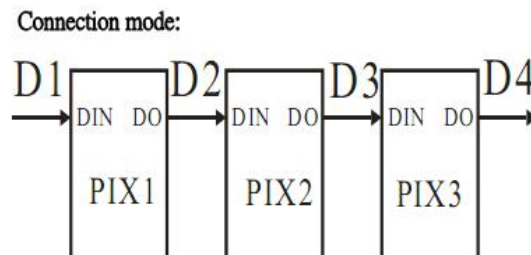
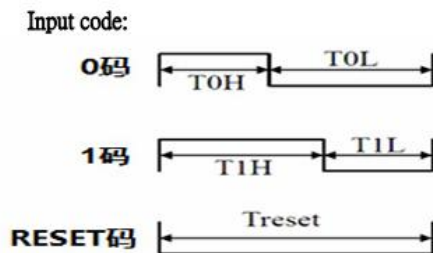

**13. The method of data transmission:**

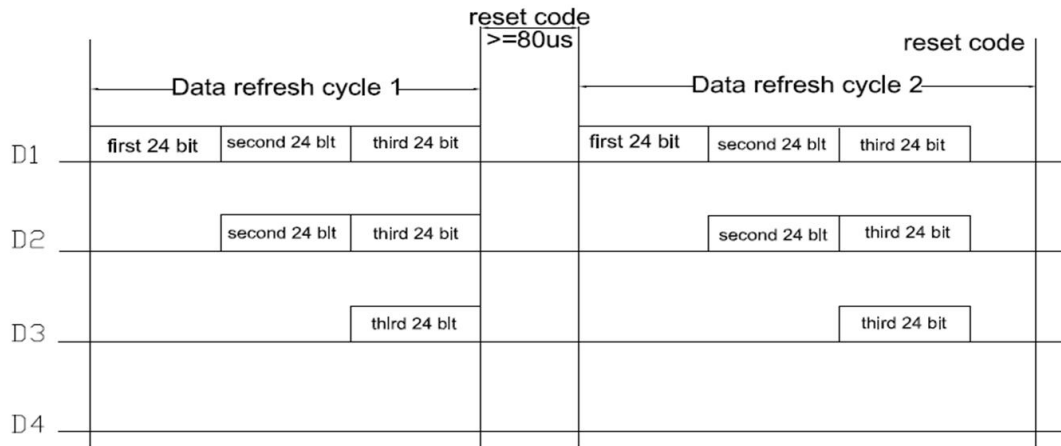

Note: the D1 sends data for MCU, D2, D3, D4 for data forwarding automatic shaping cascade circui

**14. The 24bit data Structure**

G7	G6	G5	G4	G3	G2	G1	G0	R7	R6	R5	R4
R3	R2	R1	R0	B7	B6	B5	B4	B3	B2	B1	B0

**15. The typical application circuit:**

LC8812 and LC8812-B

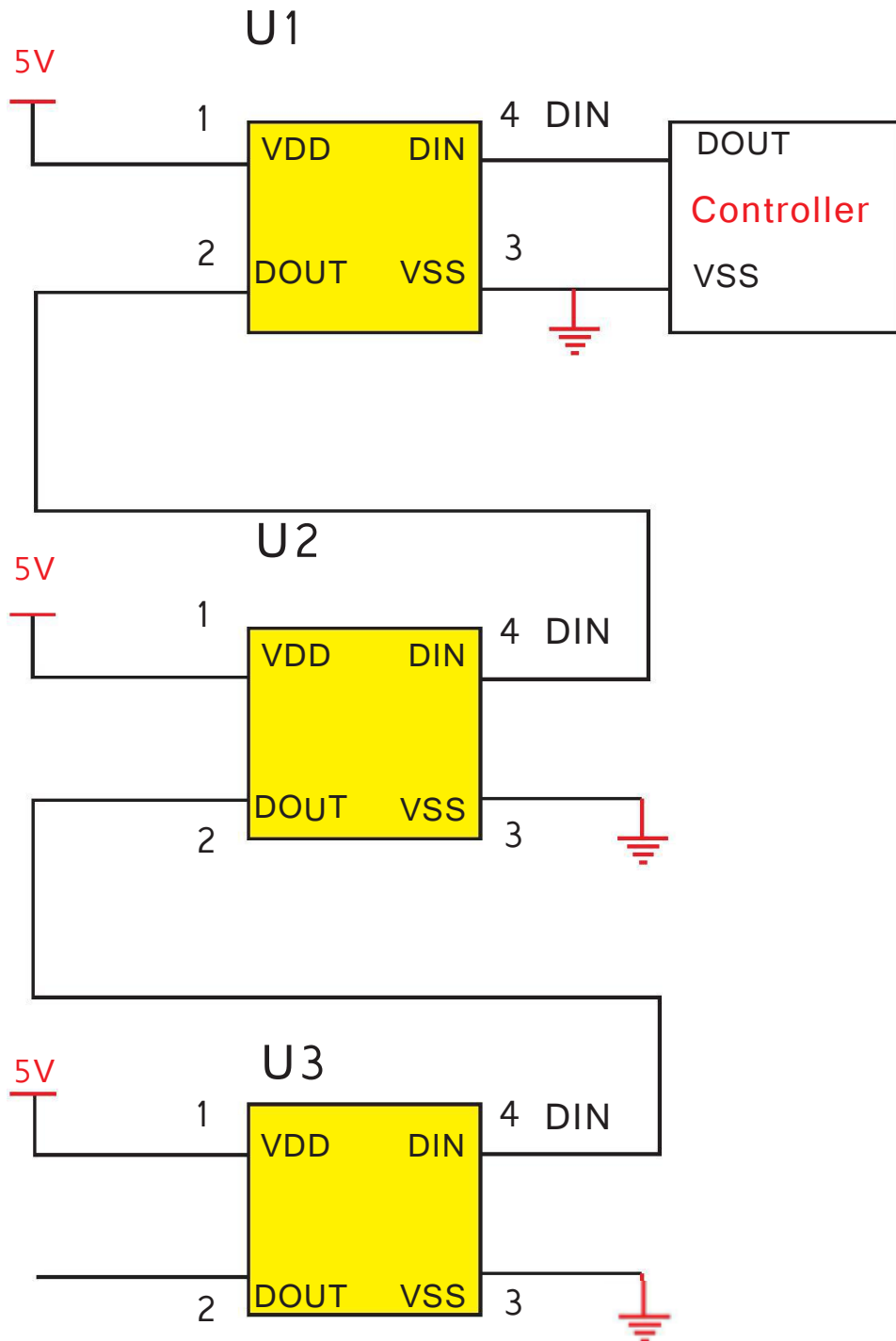

LC8812B and LC8812B-B

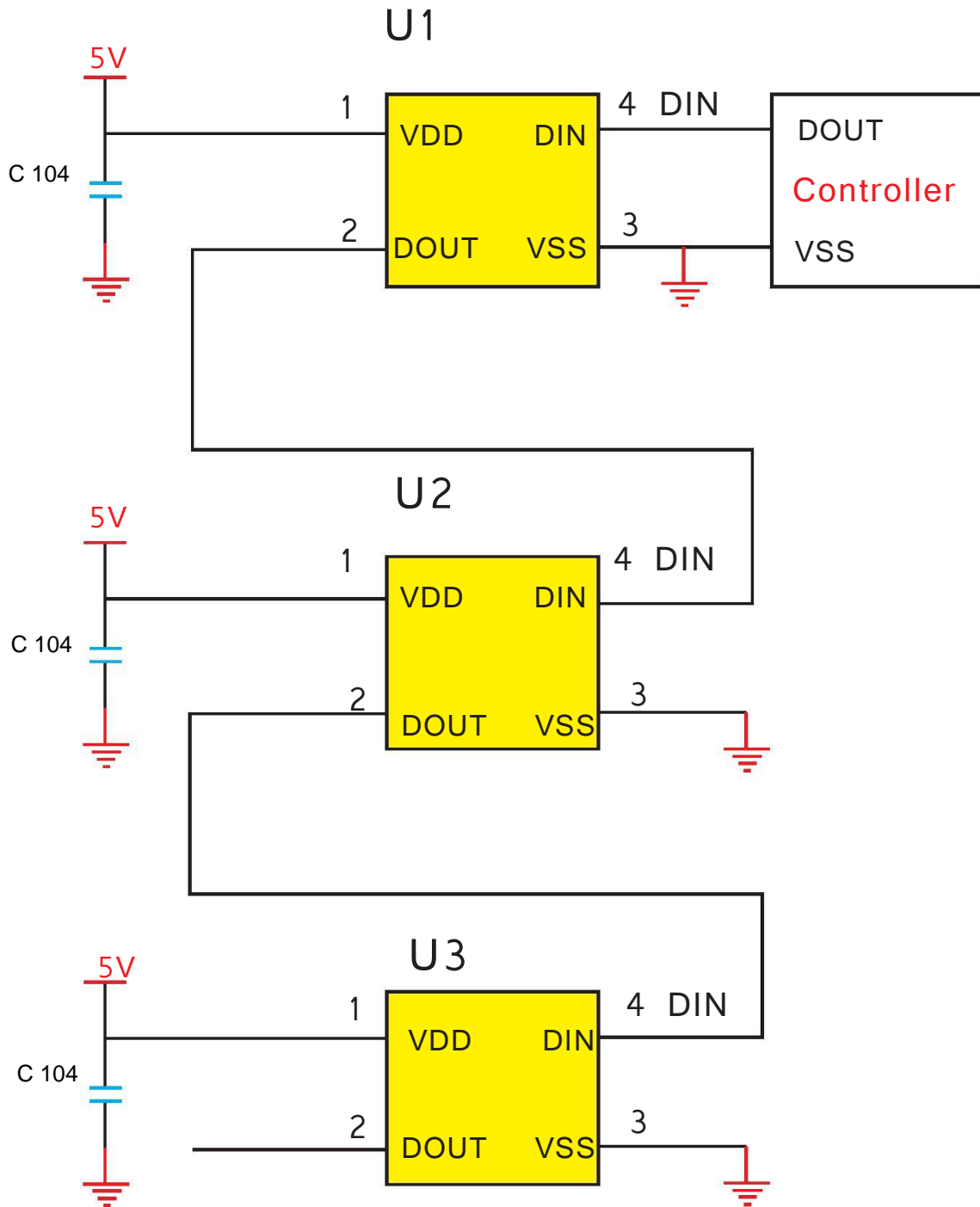



**16. Standard LED Performance Graph:**

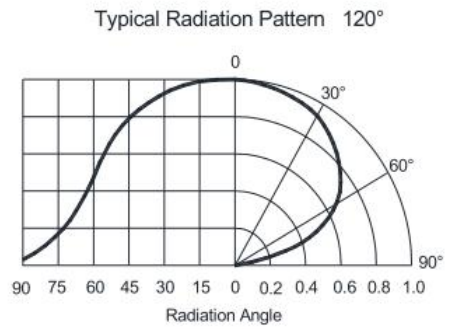
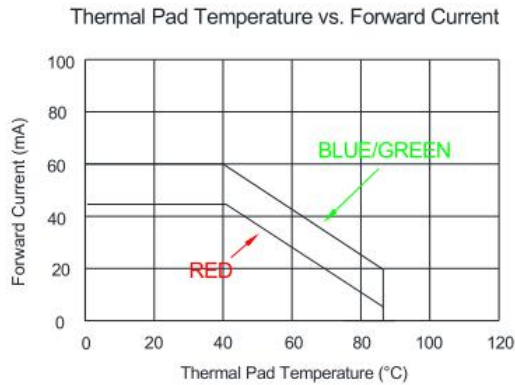
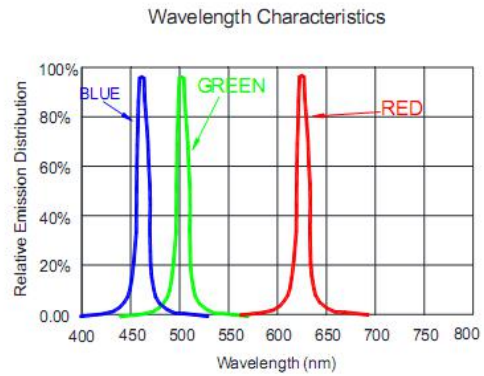
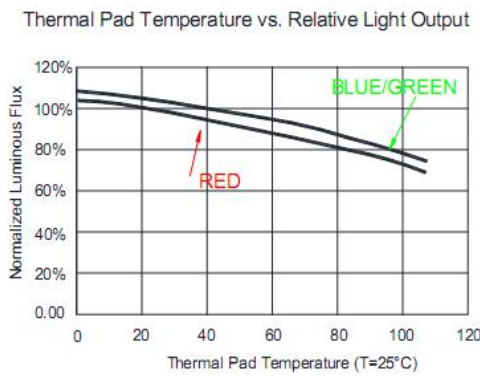
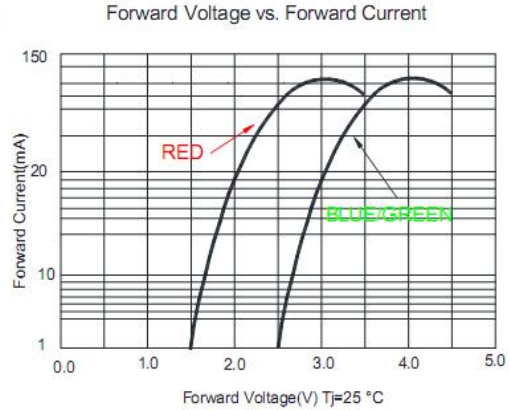
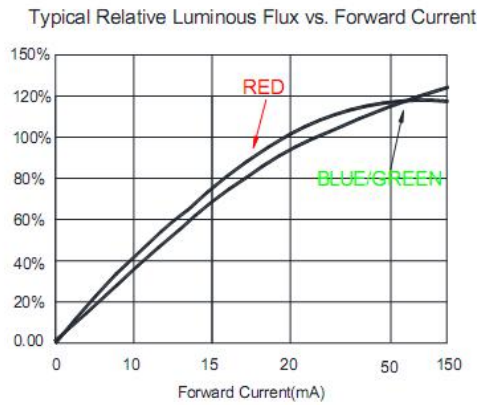

**17. Packaging Standard:**

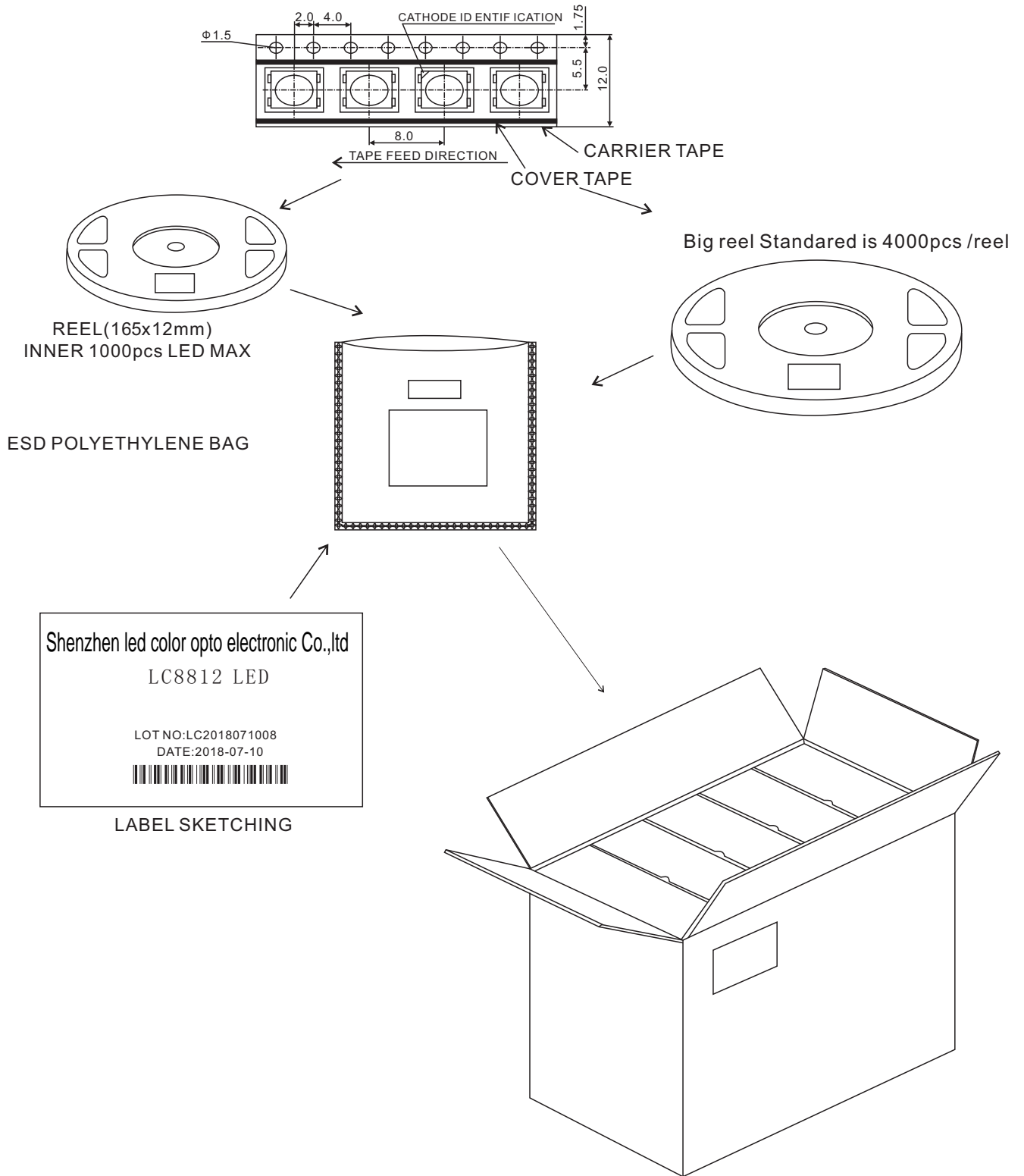

The reel pack is applied in SMD LED. The LEDs are packed in cardboard boxes after packaging in normal or anti-electrostatic bags. cardboard boxes will be used to protect the LEDs from mechanical shocks during transportation. The boxes are not water resistant and therefore must be kept away from water and moisture.

## **18. Attention**

### **18.1 Dust & Cleaning**

The LED use epoxy glue to package the 5050 Surface, epoxy surface can protect optical properties and improved anti-aging properties. However, silicone is a softer material and prone to attract dust. While a minimal amount of dust and debris on the LED will not cause significant reduction in illumination. We still need to avoid dust falling on the LED surface. After open the bags it must be used immediately.

When you use trichloroethylene or acetone to clean, sometimes the LED surface will dissolve.

Avoid using organic solvent, it is recommended that isopropyl be used as a solvent for cleaning the LEDs. When using other solvents, it should be confirmed beforehand whether the solvents will dissolve the package and the resin or not.

Do not clean the LEDs by the ultrasonic. When it is absolutely necessary, the influence as ultrasonic cleaning on the LEDs depends on factors such as ultrasonic power. Baking time and assembled condition.

Before cleaning, a pre-test should be done to confirm whether any damage to the LEDs will occur.

### **18.2 Dehumidification**

LED COLOR smart led are moisture sensitive components, In IPC/JEDEC J-STD-020 MSL Level is 6. **No Matter the Package bag is open or not ,The LED must do dehumidification in the oven for 24 hours at 70 degree before use and used within 4 hours, otherwise it need to be dehumidified again**

### **18.3 Reflow Soldering Characteristics**

In our Test, LED Color confirm those smart led are compatible with JEDEC J-STD-020C, Customers are required to follow the soldering temperature profile recommended by the solder paste manufacturer used.

Please note that this general guideline may not apply to all PCB design and reflow soldering equipment configurations.

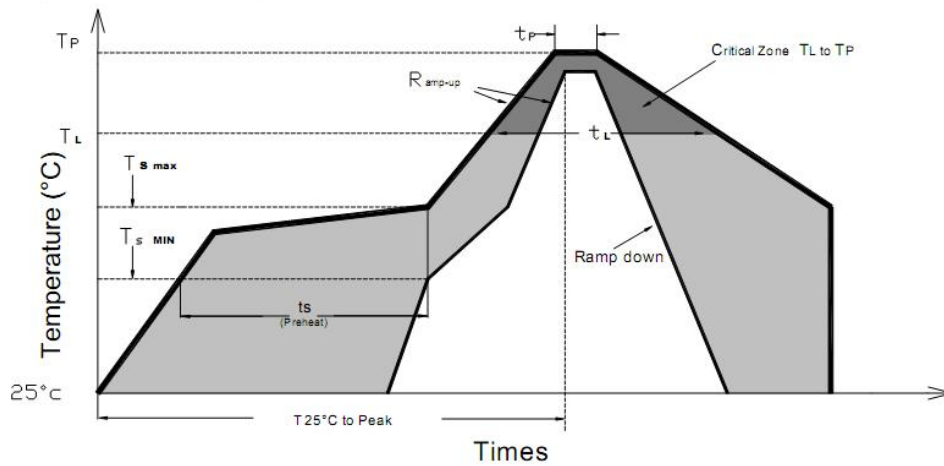

Profile Feature	Lead-Based Solder	Lead-Free Solder
Average Ramp-Up Rate (Ts max to Tp)	3 °C/second max.	
Preheat: Temperature Min (Ts min)	100°C	150°C
Preheat: Temperature Min (Ts max)	150°C	200°C
Preheat: Time (ts min to ts max)	60-120 seconds	60-180 seconds
Time Maintained Above: Temperature (TL)	183 °C	217 °C
Time Maintained Above: Time (tL)	60-150 seconds	60-150 seconds
Peak/Classification Temperature (TP)	215 °C	238 °C
Time Within 5°C of Actual Peak Temperature (tp)	<10 seconds	<10 seconds
Ramp-Down Rate	6 °C/second max	6 °C/second max
Time 25 °C to Peak Temperature	<6 minutes max	<6 minutes max

Note: All temperatures refer to topside of the package, measured on the package body surface.

#### 18.4. Anti-static and surge protection for IC devices

Static electricity and surges can damage the LED products of IC devices, so appropriate protective measures must be taken;

The signal input and output ports of IC devices must be connected in series with protective resistors to prevent product failure due to surge or electrostatic shock ports;

In order to protect the LED products of IC devices, whenever you encounter LEDs, wear anti-static straps, anti-static straps and anti-static gloves.

All devices and equipment must be grounded

It is recommended that each product be tested before shipment for relevant electrical tests to select defective products due to static electricity.

In the design of the circuit, consideration should be given to eliminating the surge to the LED

### 18.5 Other requirements

SMT nozzle requirements: (red circle refers to the inside diameter of the nozzle)

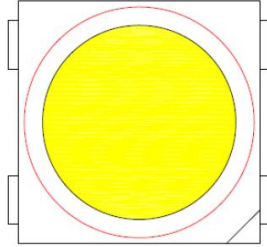

OK (the inside diameter of the nozzle is larger than the light-emitting area of the lamp)

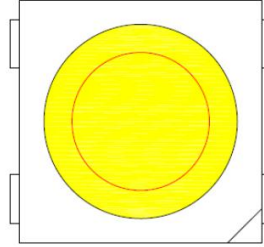

NG (the inside diameter of the nozzle is smaller than the lighting area of the lamp)

Pressing the colloid surface will affect the reliability of LED because the LED is advanced silicone-gel. And therefore precautions should be taken to avoid the strong pressure on the component. It's proper to make the LED be used in safe condition when using a suction nozzle. Silicon packing with soft and elastic, it greatly reduces thermal stresses and unable to bear external mechanical forces. Therefore, preventive measures should be taken in process of manually handling.

① Clip the LED from its side. Neither directly touch the gel surface with the hand or sharp instrument, it may damage its internal circuit.

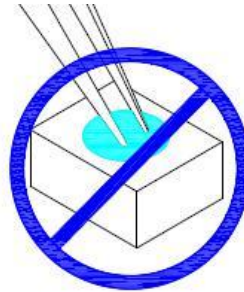
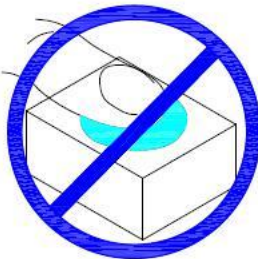
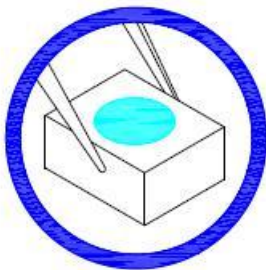

② Not to be double stacked, it may damage its internal circuit.

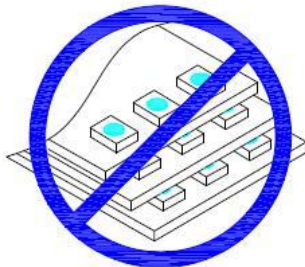

- ③ Can not be stored in or applied in the acidic sites of PH<7.



**Modify Records**

<b>Item NO.</b>	<b>Rev. No.</b>	<b>Modify Content Summary</b>	<b>Signature</b>	<b>Date</b>
<b>LC8812 RGB</b>	<b>01</b>	<b>Initial Document</b>	<b>Andy Zhu</b>	<b>2018-07-09</b>